

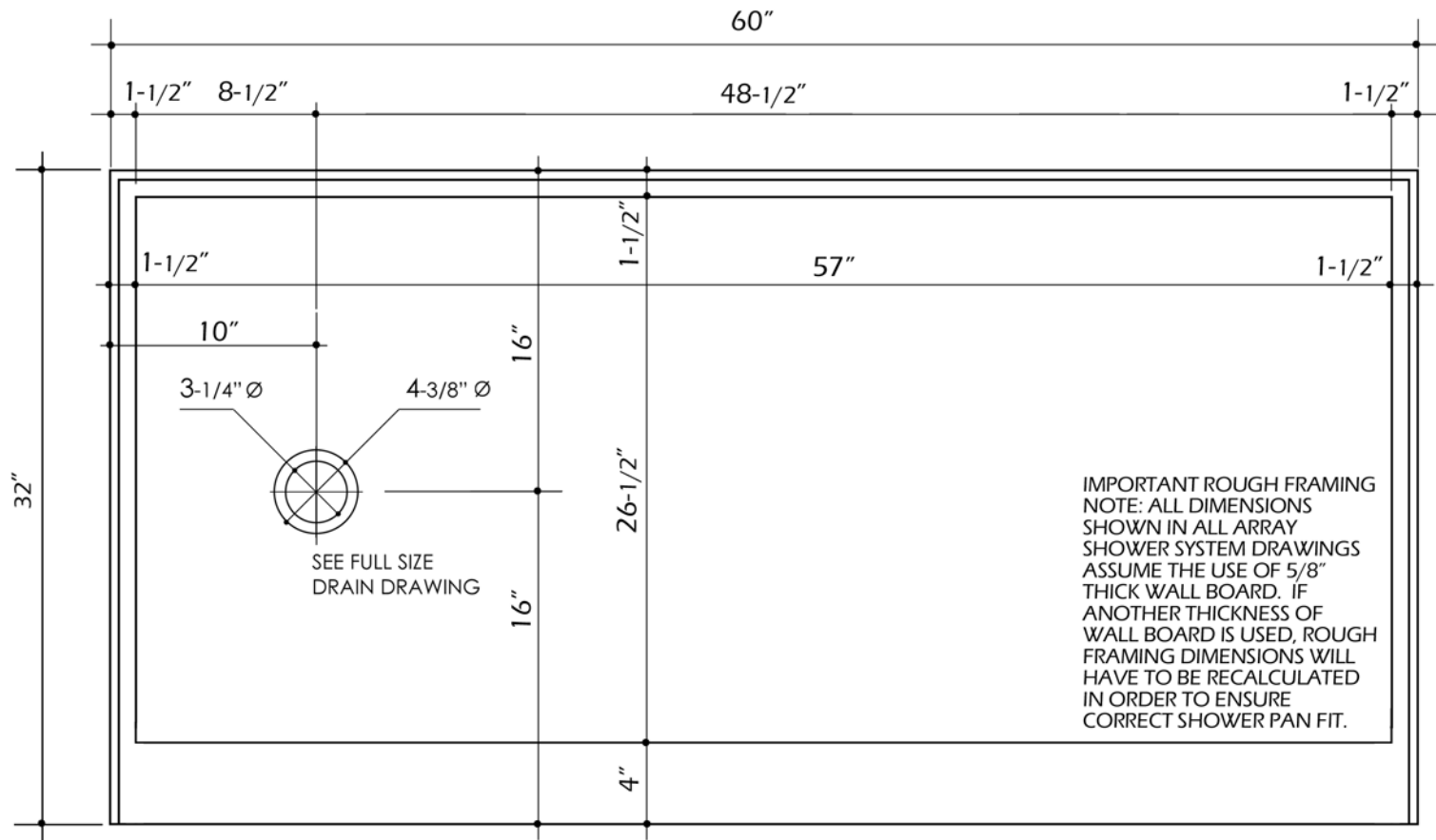

SP3260L
SOLID SURFACE
SHOWER PAN

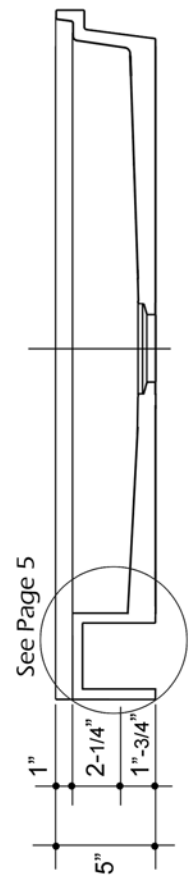

SP3260L SHOWER PAN DIMENSIONS
32"D X 60"W

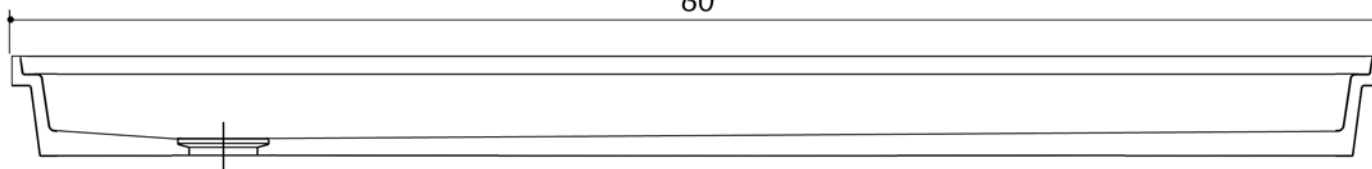

SCALE: NONE

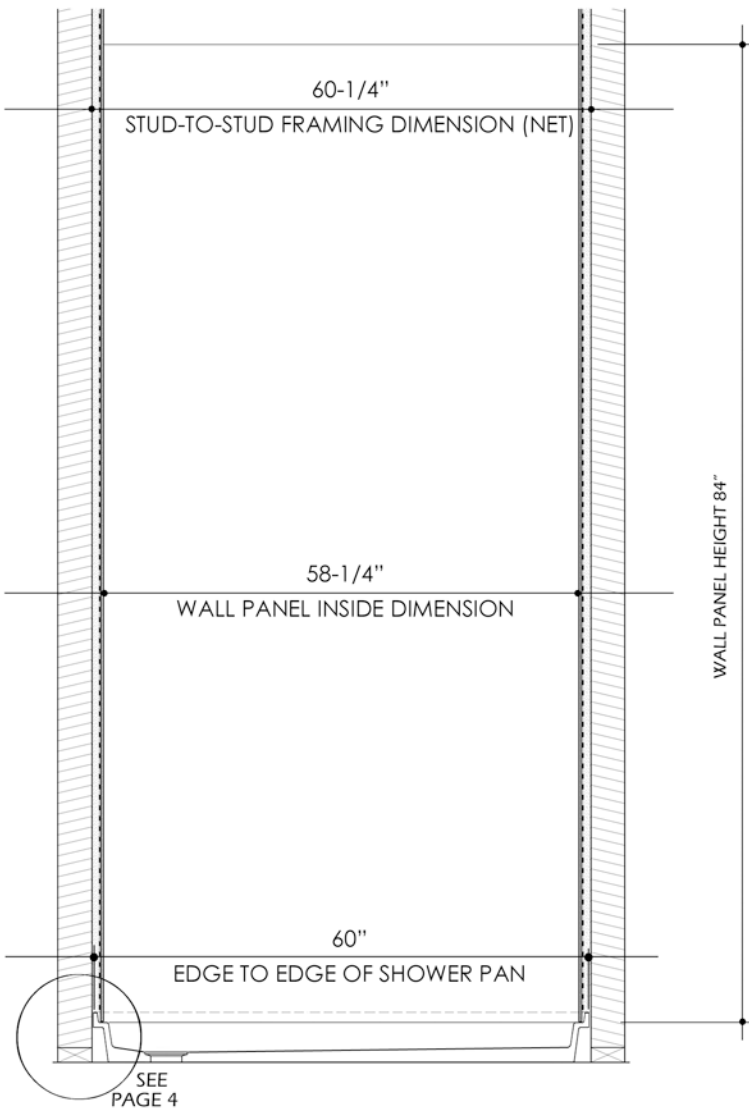

FRONT SECTION INSTALLATION

SCALE: NONE

IMPORTANT ROUGH FRAMING
NOTE: ALL DIMENSIONS
SHOWN IN ALL ARRAY
SHOWER SYSTEM DRAWINGS
ASSUME THE USE OF 5/8"
THICK WALL BOARD. IF
ANOTHER THICKNESS OF
WALL BOARD IS USED, ROUGH
FRAMING DIMENSIONS WILL
HAVE TO BE RECALCULATED
IN ORDER TO ENSURE
CORRECT SHOWER PAN FIT.

SP3260L
SHOWER PAN DIMENSIONS
32"D X 60"W

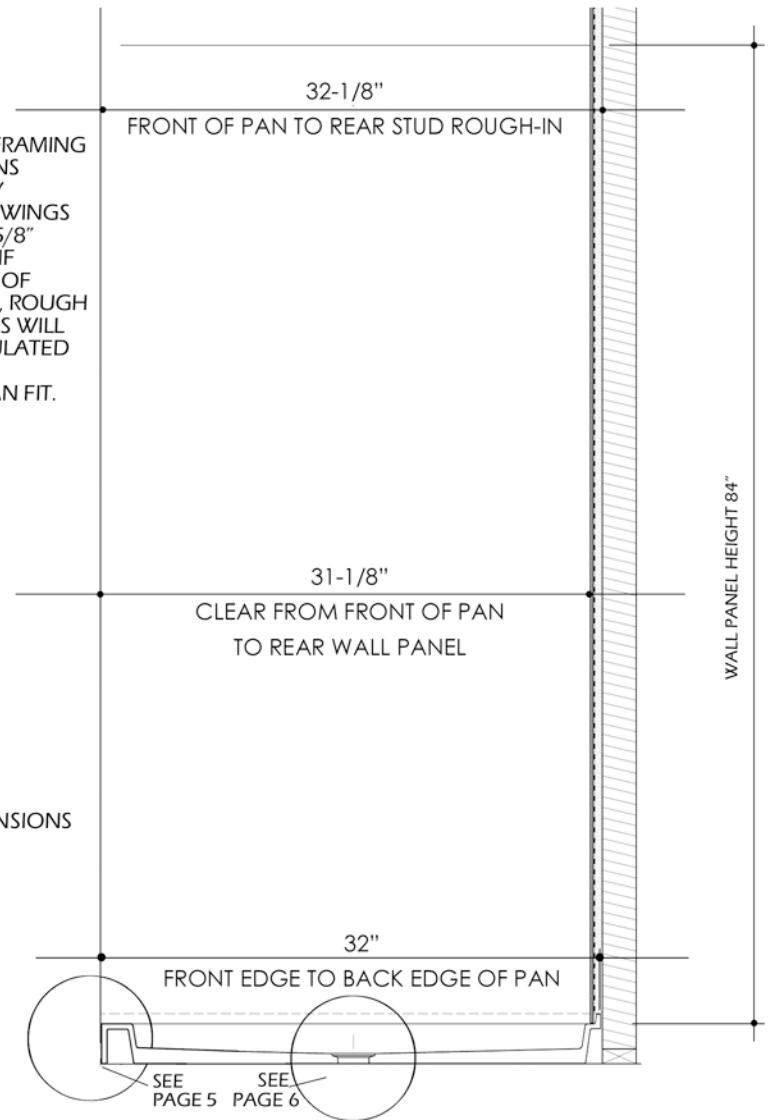

SIDE SECTION INSTALLATION

SCALE: NONE

IMPORTANT ROUGH FRAMING NOTE:

ALL DIMENSIONS SHOWN IN ALL ARRAY SHOWER SYSTEM DRAWINGS ASSUME THE USE OF 5/8" THICK WALL BOARD. IF ANOTHER THICKNESS OF WALL BOARD IS USED, ROUGH FRAMING DIMENSIONS WILL HAVE TO BE RECALCULATED IN ORDER TO ENSURE CORRECT SHOWER PAN FIT.

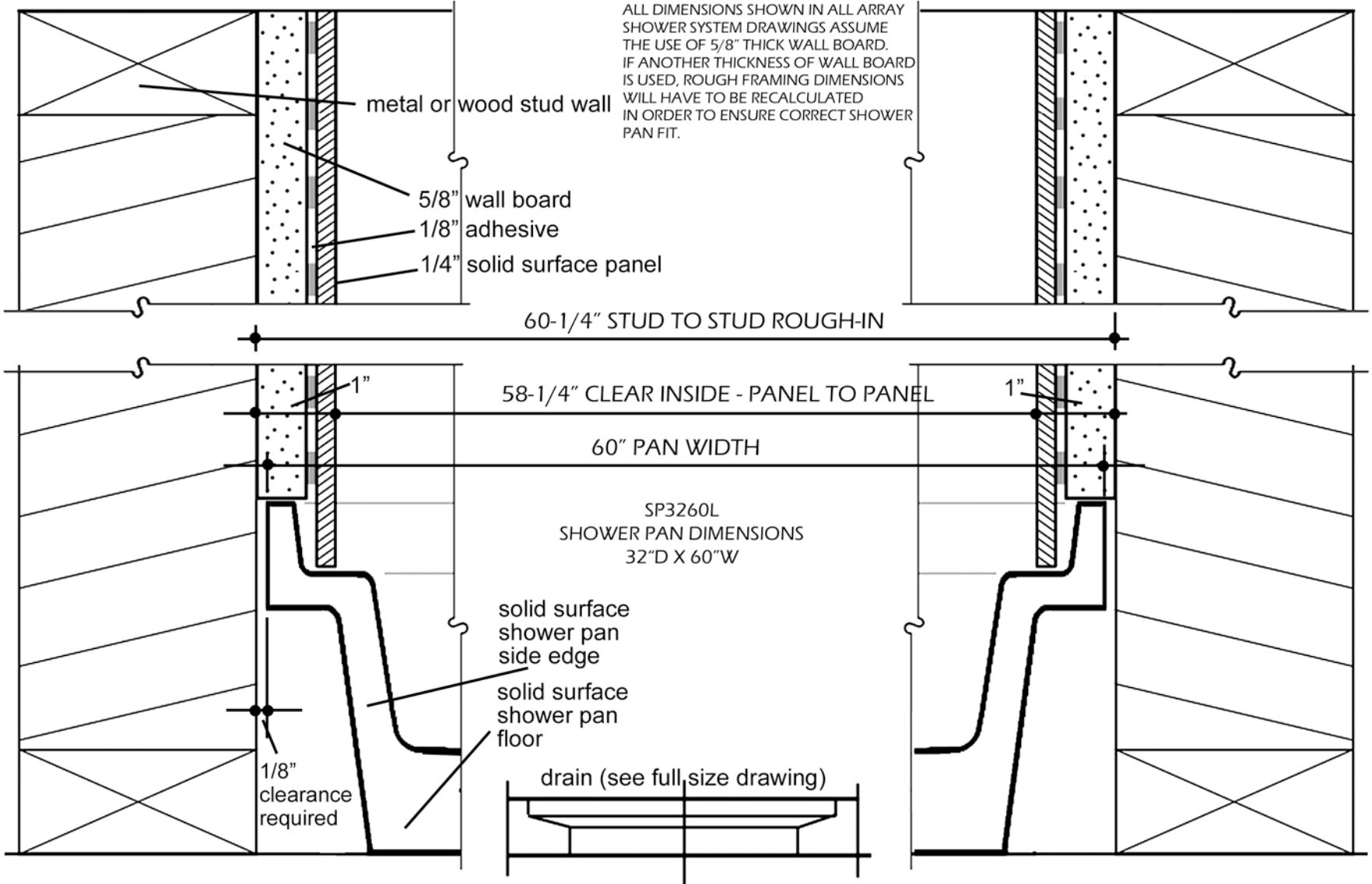

SECTION THRU FRONT VIEW OF SHOWER PAN INSTALLATION

Scale: NONE

IMPORTANT ROUGH FRAMING NOTE:

ALL DIMENSIONS SHOWN IN ALL ARRAY SHOWER SYSTEM DRAWINGS ASSUME THE USE OF 5/8" THICK WALL BOARD. IF ANOTHER THICKNESS OF WALL BOARD IS USED, ROUGH FRAMING DIMENSIONS WILL HAVE TO BE RECALCULATED IN ORDER TO ENSURE CORRECT SHOWER PAN FIT.

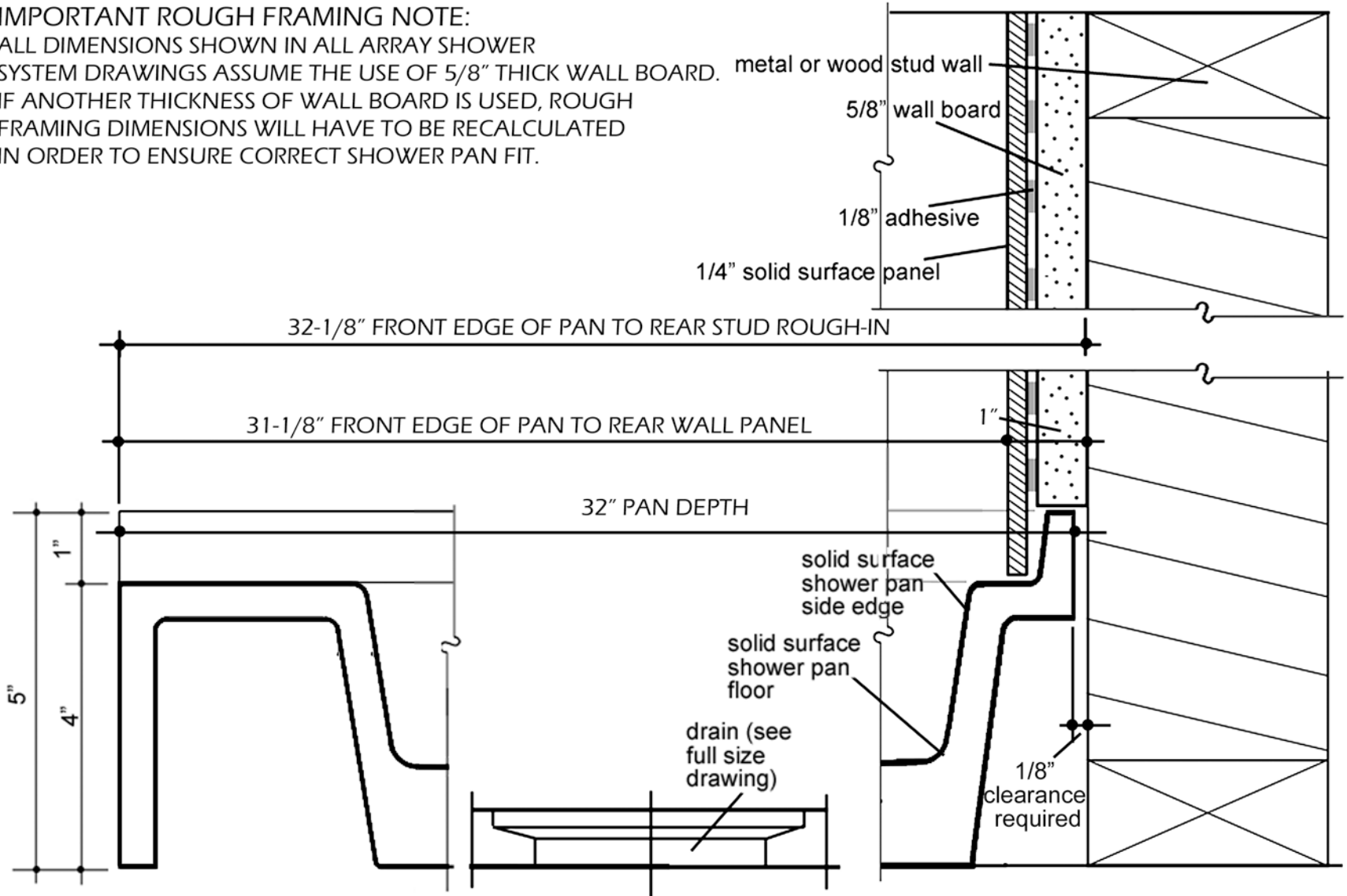

SECTION THRU SHOWER PAN INSTALLATION

Scale: NONE

3-1/4" (82mm) Ø

4-3/8" (111mm) Ø

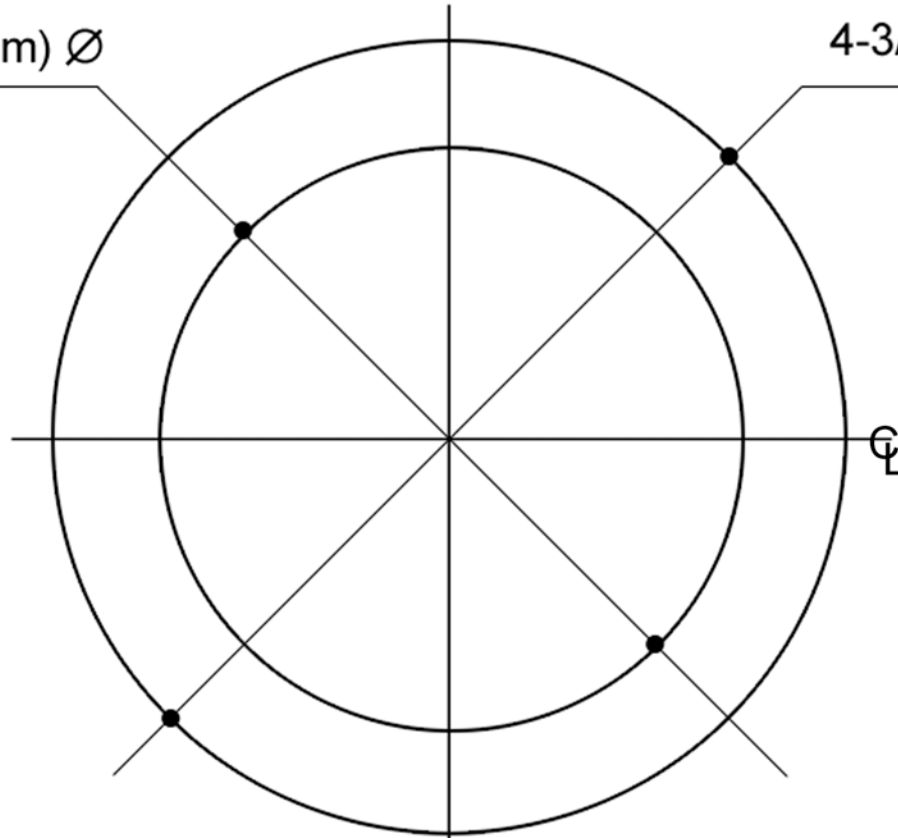

PF140NC
Drain Assembly*

*A **PF140NC** or equal Drain Assembly is required for installation of all ARRAY Shower Pans in order to guarantee a successful installation and maintain warranty.

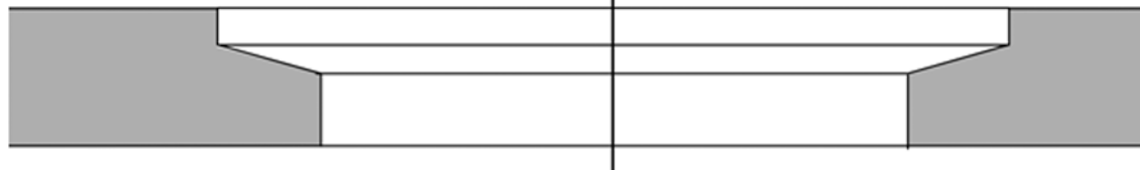

DRAWING C - DRAIN PLAN & SECTION

Scale: FULL

ARRAY Solid Surface Shower Systems Healthcare, Institutional, and Commercial Projects Installation Instructions

I. Scope of Instructions

The limited instructions offered here are general in nature and assume that the fabricators, installers, plumbers, and others involved in the installation of ARRAY Solid Surface Shower System products have experience with and understanding of solid surface shower components. If this is not the case, the fabricators, installers, plumbers and others involved should notify the General Contractor or Project Manager and contact ARRAY Solid Surface Shower System support staff members at 901.386.2375, Toll Free at 877.778.1149 for total assistance (including detailed custom instructions and shop drawings and related training program and certification opportunities by ARRAY Solid Surface Shower Systems or other organizations).

II. Important rough framing note:

ALL DIMENSIONS SHOWN IN ALL ARRAY SHOWER SYSTEM DRAWINGS ASSUME THE USE OF 5/8" THICK WALL BOARD. IF ANOTHER THICKNESS OF WALL BOARD IS USED, ROUGH FRAMING DIMENSIONS WILL HAVE TO BE RECALCULATED IN ORDER TO ENSURE CORRECT SHOWER PAN FIT AND FINAL INSIDE DIMENSIONS OF WALLS IN ADA-COMPLIANT INSTALLATIONS.

III. Shower Pan Pre-installation Preparation

- a. Drain Location - Check the rough-in opening drain location to make certain it matches the Array Shower System dimensional specifications (as shown in the Submittal drawings supplied for each Shower Pan Model). For custom installations; follow the same procedure with custom shop drawings supplied with specific product orders.
- b. Shower Wall Framing – make certain that the rough-in stud dimensions allow 1/8" space between outside edges of shower pan and adjacent stud walls (as shown in Submittal drawings).
- c. Wood Blocking for Accessory Installation - Check the wood blocking sizes and locations for grab bars, shower seats, and other accessories to ensure proper positioning for structurally sound installations in general and ADA-compliant specifications in particular. (See Submittal drawings.)
 - i. Grab Bars – install continuous 2" x 8" blocking horizontally covering the area from 30-1/2" above the slab or sub-floor to 38" above the slab or sub-floor.
 - ii. Shower Seats – Install four (4) heavy duty studs (min. 16ga or wood equivalent) from bottom plate to top plate as follows: one (1) stud on the left, two (2) studs back to back (screwed or nailed together) and 16" to the right of the first stud. Install the fourth stud 16" to the right of the two studs joined together. Install one double layer of 3/4" plywood (16" x 48") flush with the surface of all the studs mentioned above and running from the bottom plate to 48" above the bottom plate in both left and right sections. The center pair of studs is to be a specified distance from the intersection of the rear wall framing
 - iii. Other Accessories - All other accessories require at least 2" x 6" wood blocking that is to be located to accept all fasteners

IV. Shower Pan Installation

- a. Check the floor condition. Dry-fit the shower pan to make certain that the floor is level and the shower pan does not rock. (If required, level the floor with mortar mixture or thin set material according to best practices standards, local codes, and/or architectural or engineering specifications.)
- b. Check to make certain that proper 1/8" clearance exists between the edges of the shower pan and the side wall framing.
- c. Hook up the shower drain according to the drain installation instructions.
- d. For ADA transfer shower applications, install the shower access ramp with silicone or hard seam (if required).
- e. Cover the shower pan floor with cardboard, plastic sheeting, or similar materials to prevent possible damage during additional construction.

V. Shower Wall Installation

- a. Install moisture resistant wallboard.
- b. Carefully measure and cut any openings for plumbing or accessories in the wall panels as required.
- c. Install 1/4" thick ARRAY Solid Surface wall panels utilizing 1/8" thick adhesive spotted on wallboard as appropriate. Use adhesive to secure wall panels at corners. Bottom edge of wall panels to be seated on shower pan lip. Seal all joints with silicone.
- d. When penetrating the ARRAY Solid Surface wall panels to attach accessories, the penetrations must be larger than the fasteners so as to ensure that fasteners do not come in contact with the wall panels (which could potentially result in a crack in the panel).

VI. Disclaimer:

The information supplied above is given free of charge. It is based upon generally accepted technical and installation data that is common to healthcare, institution, and commercial construction applications. Any information provided herein is subordinate to architectural or engineering drawings or specifications associated with any specific project as well as to any building or ADA code enforcement guidelines. ARRAY Shower Systems assumes no responsibility for results obtained or damages incurred from the use of ARRAY materials either in whole or in part by the purchaser of such materials.

MAXSTONE INTERNATIONAL, LLC

7401 Adrienne Place, Memphis, TN 38133, 901.386.2375, Toll Free 877.778.1149, FAX 901.386.6668, www.ArrayShowers.com

SP3260L FOUNDATION DETAILS

SP3260L SHOWER PAN
DIMENSIONS
32"D X 60"W

Shower Pan Pre-installation
Preparation

a. **Drain Location** - Check the rough-in opening drain location to make certain it matches the Array Shower System dimensional specifications (as shown on this page) For custom installations, follow the same procedure with custom shop drawings supplied with specific ARRAY product orders.)

b. **Shower Wall Framing** - make certain that the rough-in stud dimensions allow 1/8" space between outside edges of shower pan and adjacent stud walls (as shown on this page).

FOR ADDITIONAL SUPPORT SERVICES AND PRODUCT INFORMATION (INCLUDING CUSTOM SHOP DRAWINGS OR INSTALLATION INSTRUCTIONS, CALL 901.386.2375, TOLL FREE 877.778.1149, OR FAX 901.386.6668.

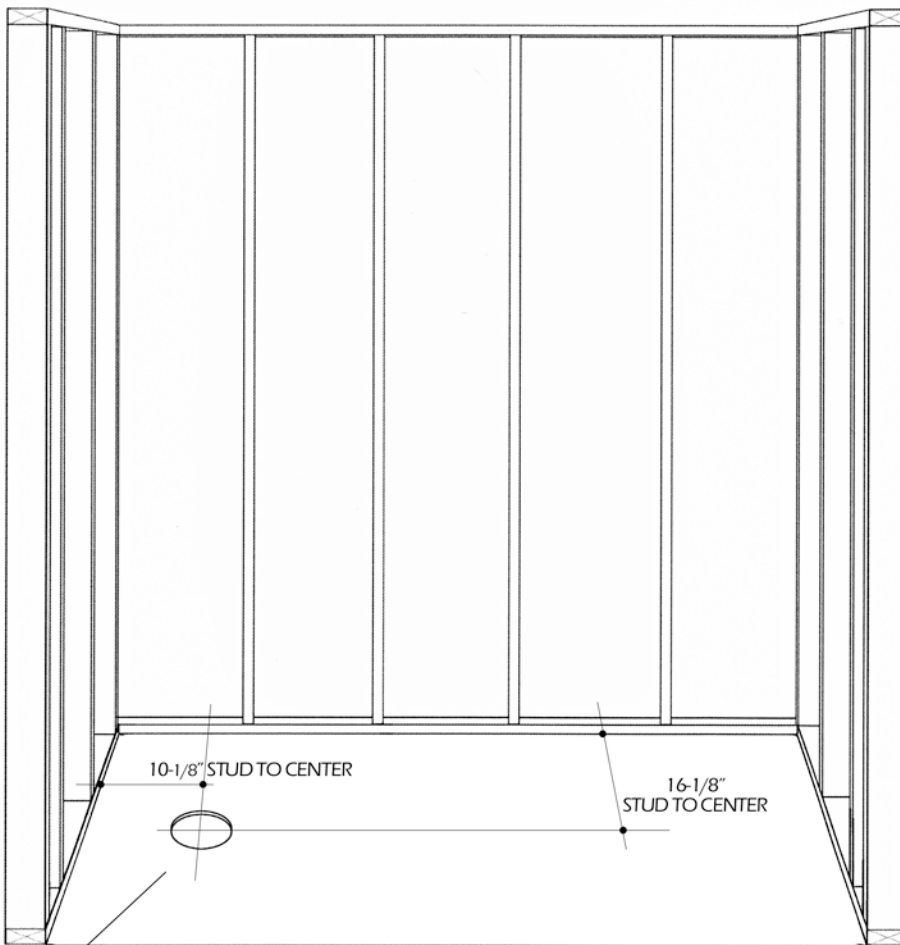

DESIGNATED SHOWER PAN AREA ON CONCRETE SLAB WITH DRAIN ROUGH-IN

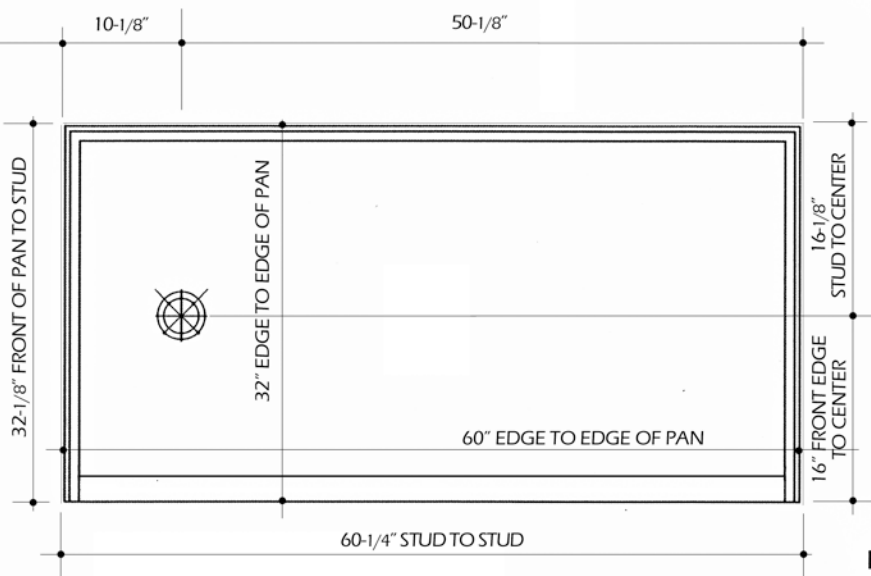

SP3260L Left Drain

MAXSTONE INTERNATIONAL, LLC
7401 Adrienne Place, Memphis, TN 38133
901.386.2375, Toll Free 877.778.1149
FAX 901.386.6668
www.ArrayShowers.com



SP3260L SHOWER PAN INSTALLATION DETAILS

SP3260L SHOWER PAN DIMENSIONS
32"D X 60"W

Shower Pan Installation

- a. Check the floor condition. Dry-fit the shower pan to make certain that the floor is level and the shower pan does not rock. (If required, level the floor with mortar mixture or thin set material according to best practices standards, local codes, and/or architectural or engineering specifications.)
- b. Check to make certain that proper 1/8" clearance exists between the edges of the shower pan and the side wall framing.
- c. Hook up the shower drain according to the drain installation instructions.
- e. Cover the shower pan floor with cardboard to prevent possible damage during additional construction.

FOR ADDITIONAL SUPPORT
SERVICES AND PRODUCT
INFORMATION (INCLUDING
CUSTOM SHOP DRAWINGS OR
INSTALLATION INSTRUCTIONS,
CALL 901.386.2375,
TOLL FREE 877.778.1149,
OR FAX 901.386.6668.

MAXSTONE INTERNATIONAL, LLC
7401 Adrienne Place, Memphis, TN 38133
901.386.2375, Toll Free 877.778.1149
FAX 901.386.6668
www.ArrayShowers.com

SP3260L WOOD BLOCKING FOR ACCESSORY INSTALLATION DETAILS

SP3260L SHOWER PAN DIMENSIONS
32"D X 60"W

If applicable, check the wood blocking sizes and locations for grab bars and fold-down seats to ensure proper positioning for structurally sound installations.

- i. Grab Bars – install continuous 2" x 8" blocking horizontally covering the area from 30.5" above the sub-floor to 38" above the slab or sub-floor.
- ii. Shower Seats – Install four (4) heavy duty studs (min. 16ga or wood equivalent) from bottom plate to top plate as follows: one (1) stud on the left, two (2) studs back to back (screwed or nailed together) and 16" to the right of the first stud. Install the fourth stud 16" to the right of the two studs joined together. Install one double layer of 3/4" plywood (16" x 48" flush with the surface of all the studs mentioned above and running from the bottom plate to 48" above the bottom plate in both left and right sections. The center pair of studs is to be a specified distance from the intersection of the rear wall framing
- iii. Other Accessories - All other accessories require at least 2" x 6" wood blocking that is to be located to accept all fasteners

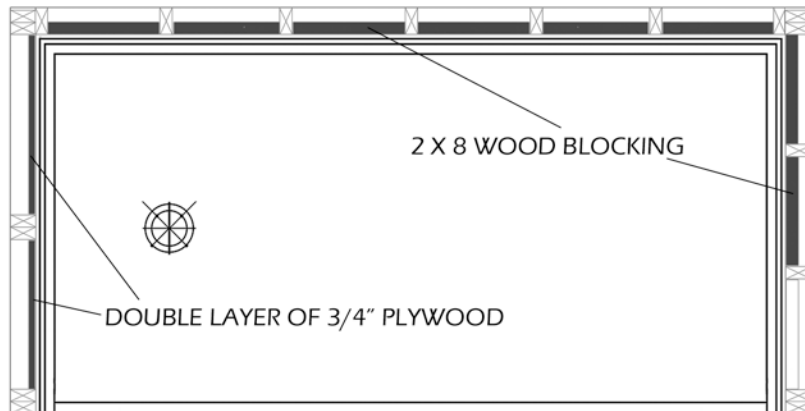
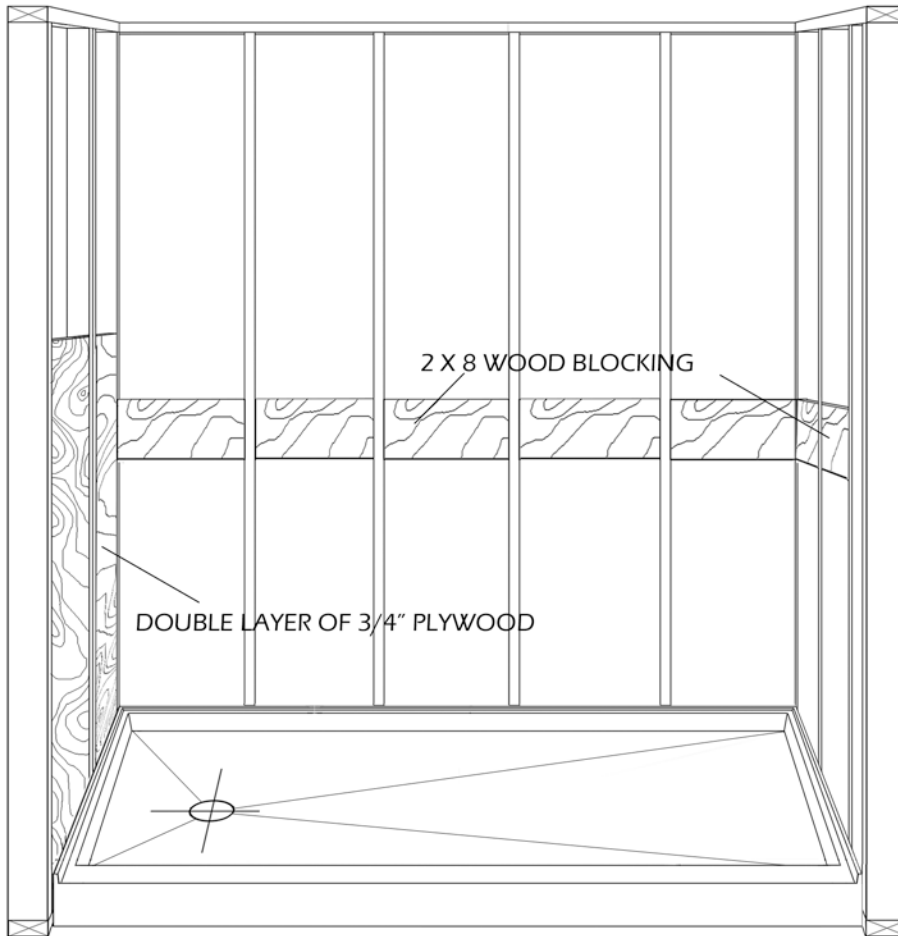

FOR ADDITIONAL SUPPORT SERVICES AND PRODUCT INFORMATION (INCLUDING CUSTOM SHOP DRAWINGS OR INSTALLATION INSTRUCTIONS, CALL 901.386.2375, TOLL FREE 877.778.1149, OR FAX 901.386.6668.

MAXSTONE INTERNATIONAL, LLC
7401 Adrienne Place, Memphis, TN 38133
901.386.2375, Toll Free 877.778.1149
FAX 901.386.6668
www.ArrayShowers.com

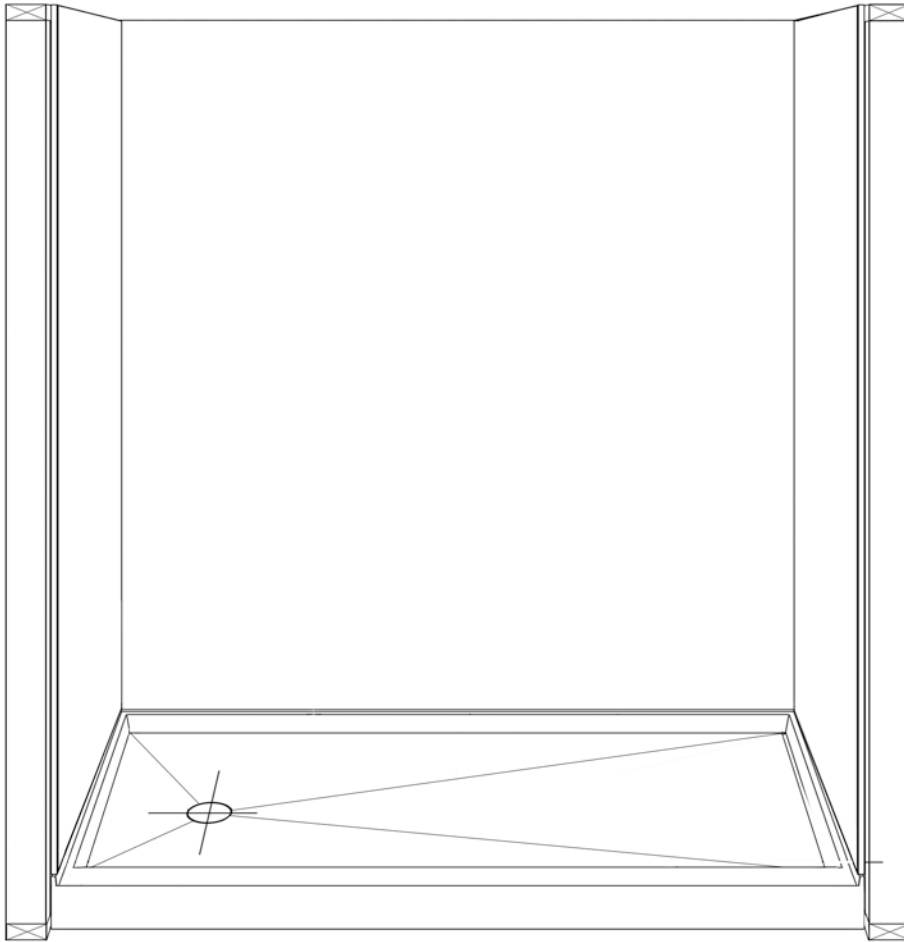

SP3260L MOISTURE RESISTANT WALLBOARD DETAILS

Shower Wall Installation

- a. Install moisture resistant wallboard.
- b. Carefully measure and cut any openings for plumbing or accessories in the wall panels as required.

FOR ADDITIONAL SUPPORT SERVICES AND PRODUCT INFORMATION (INCLUDING CUSTOM SHOP DRAWINGS OR INSTALLATION INSTRUCTIONS, CALL 901.386.2375, TOLL FREE 877.778.1149, OR FAX 901.386.6668.

MAXSTONE INTERNATIONAL, LLC
7401 Adrienne Place, Memphis, TN 38133
901.386.2375, Toll Free 877.778.1149
FAX 901.386.6668
www.ArrayShowers.com

SP3260L SOLID SURFACE WALL PANEL DETAILS

Install 1/4" thick ARRAY Solid Surface wall panels utilizing 1/8" thick adhesive spotted on wallboard as appropriate. Use adhesive to secure wall panels at corners. Bottom edge of wall panels to be seated on shower pan lip. Seal all joints with silicone.

When penetrating the ARRAY Solid Surface wall panels to attach accessories, the penetrations must be larger than the fasteners so as to ensure that fasteners do not come in contact with the wall panels (which could potentially result in a crack in the panel).

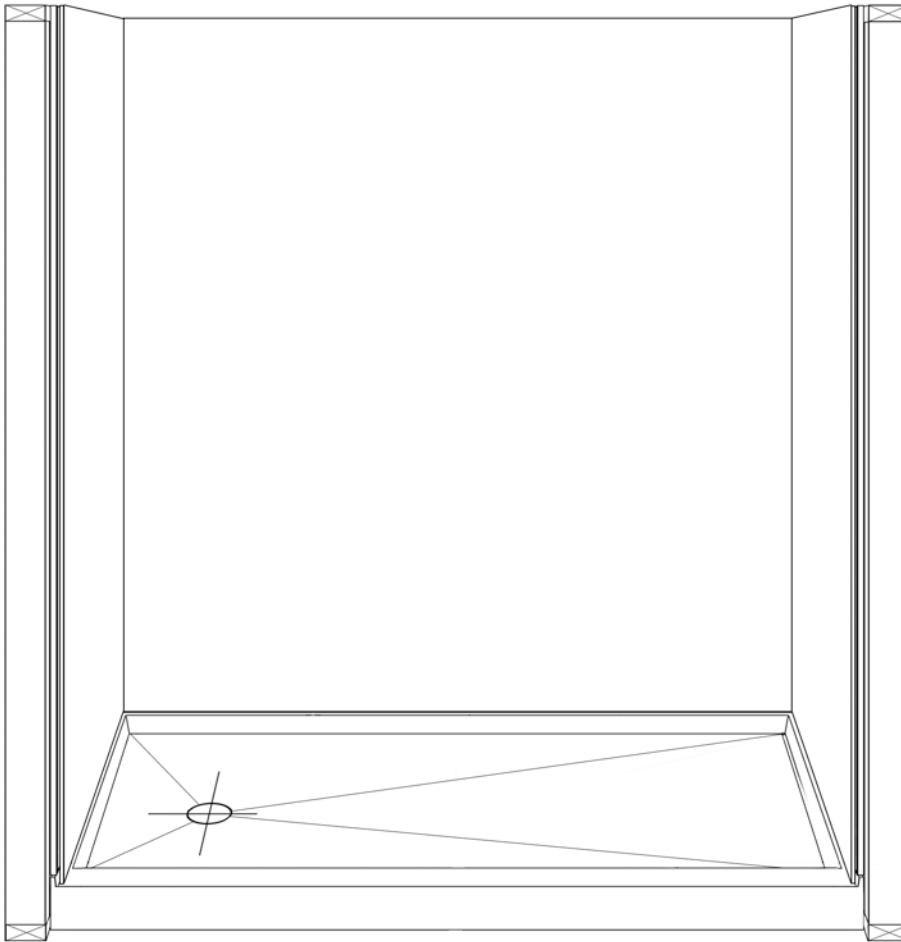

ARRAY Standard Wall Panel Sizes:

- 60" x 96" x 1/4"
- 36" x 96" x 1/4"

FOR ADDITIONAL SUPPORT SERVICES AND PRODUCT INFORMATION (INCLUDING CUSTOM SHOP DRAWINGS OR INSTALLATION INSTRUCTIONS, CALL 901.386.2375, TOLL FREE 877.778.1149, OR FAX 901.386.6668.

MAXSTONE INTERNATIONAL, LLC
7401 Adrienne Place, Memphis, TN 38133
901.386.2375, Toll Free 877.778.1149
FAX 901.386.6668
www.ArrayShowers.com